

P/N: FAT74015

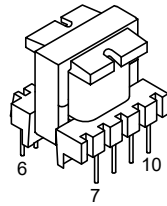

Outline Dimensions (Unit:mm)

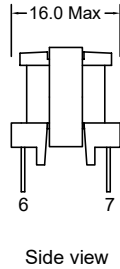
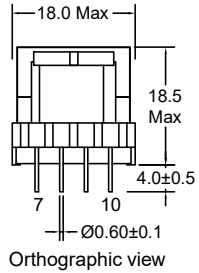

Stereogram

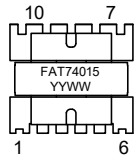

Top view

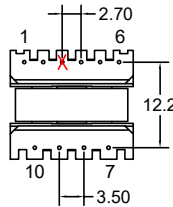

Bottom view

REMARK:

1. Fixed Core With 2Ts Tape.
2. Remove pin3.
3. Product vacuum impregnation.

Electrical Schematic

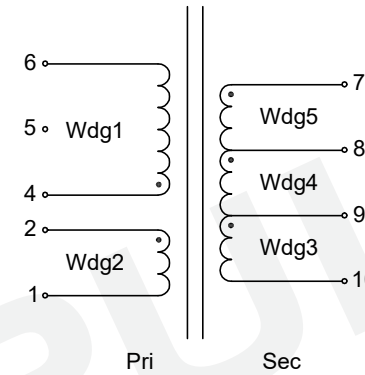

"." Dotted terminal

General Properties:

- Operating Temperature:-40°C to +105°C.
- Storage Temperature:-25°C to +85°C.
- Insulation Class:B.

Wave Soldering

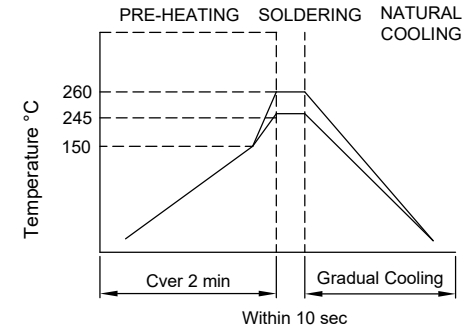

Note:

- 1.Never Contact the ceramic with the iron tip:
- 2.1.0mm tip diameter(max).

Electrical Characteristics

- Inductance : L4-6= 1.80mH ±10%,at 1KHz,0.3V.
- D.C.Resistance : 1-2= 0.40 ohms Max.
- 4-6= 2.80 ohms Max.
- 7-10= 0.40 ohms Max.
- Turns Ratio : Wdg1:Wdg2:Wdg3:Wdg4:Wdg5= 1:0.117:0.05:0.092:0.083±2%,at 20KHz,1V.
- Hipot : Pri-Sec : 4000VAC/5mA/2S.
- Pri&Sec-Core : 1500VAC/5mA/2S.
- Pri-Aux : 1500VAC/5mA/2S.

				Tianchang Fuan Electronic Co Ltd www.fuantronics.net TEL: +86-550-7814888 FAX: +86-550-7831133	 Tolerances unless otherwise specified: (.X)±0.50 (XX)±0.25 Unit of measurement: mm	Make: Qiumei.Liu Checked: Beson. zhan Approved: Anson. zhan	DRAWING TITLE EE16 FLYBACK TRANSFORMER Material Number: A2174015S000	Customer P/N: Document/Rev: 1011032/00 Specification Sheet: 1 of 2 Date of Recognition: Aug./04/2020
00	Release of the new edition.	Beson	2020.08.04					
REV	DESCRIPTION	APPD	DATE					

P/N: FAT74015



List of UL Certificate:

No.	Part Name	Mat'l Description	Supplier	UL Number
1	Bobbin	EI-1616/T375J/FAY01091	Chang Chun Plastics Co Ltd	E59481
2	Copper wire	2UEW-F/155C	Dong Guan YiDa Industrial Co Ltd	E344055
		2UEW-F/155C	Elektrisola Hangzhou Co Ltd	E258243
3	Triple insulated wire	TIW-B/130C	Shanghai SuRan Electronic Technology Co Ltd	E335392
		TRW-B/130C	Great Leoflon Industrial Co Ltd	E211989
4	Core	EE16/15/5 HPP4	Anhui Hualin Magnetic Technology Go Ltd	N/A
		EE16/15/5 GP4	Su Zhou Guanda Magnet Co Ltd	N/A
5	Tape	JY25-A(b)/130C(Faint Yellow)	Jingjiang Jingyi Adhesive Product Co Ltd	E246950
		CT (b)(g)/130C(Faint Yellow)	JingJiang Yahua Pressure Sensitive Glue Co Ltd	E165111
6	Varnish	T-4260(a)/MW80-C	SuZhou TaiHu Electric Advanced Material Co Ltd	E228349

Label:

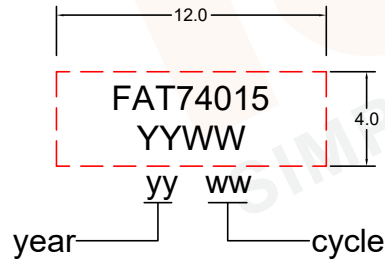

Remark:

1. Use Laser printing;
2. Clear writing and legibility, not easy to erase;
3. Border here means size range, not be printed;
4. Font: Arial; Height: 1.20mm.

				Tianchang Fuan Electronic Co Ltd www.fuantronics.net TEL: +86-550-7814888 FAX: +86-550-7831133	Tolerances unless otherwise specified: (.X)±0.50 (XX)±0.25 Unit of measurement: mm	Make: Qiumei.Liu Checked: Beson. zhan Approved: Anson. zhan	DRAWING TITLE EE16 FLYBACK TRANSFORMER Material Number: A2174015S000	Customer P/N: Document/Rev: 1011032/00 Specification Sheet: 2 of 2 Date of Recognition: Aug./04/2020
00	Release of the new edition.	Beson	2020.08.04					
REV	DESCRIPTION	APPD	DATE					